

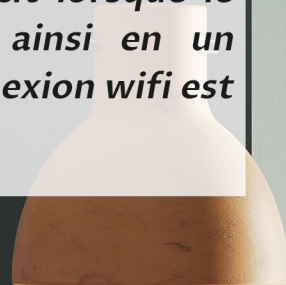







Le **SOUND UP** est un poêle à granulés étanche de forme ronde avec des dimensions compactes. Il est équipé d'une sortie concentrique supérieur en 80/130. a vitre Magic Glass s'obscurcit lorsque le poêle est éteint, le transformant ainsi en un véritable objet de décoration. La Connexion wifi est intégrée de série.



-   
ÉTANCHE
-   
CAPACITÉ CHARGEMENT 11
-   
PROGRAMMABLE
-   
ECO-STOP
-   
ON/OFF  
VENTILATEUR DÉBRAYABLE
-   
WIFI
-   
TÉLÉCOMMANDE (OPTION)
-   
ECO DESIGN 2023

AIR 

# SOUND UP



45010446 45010447 45010448

Puissance	Rendement	Performance énergie	Flamme verte
7 kW	90%	A <sup>+</sup>	

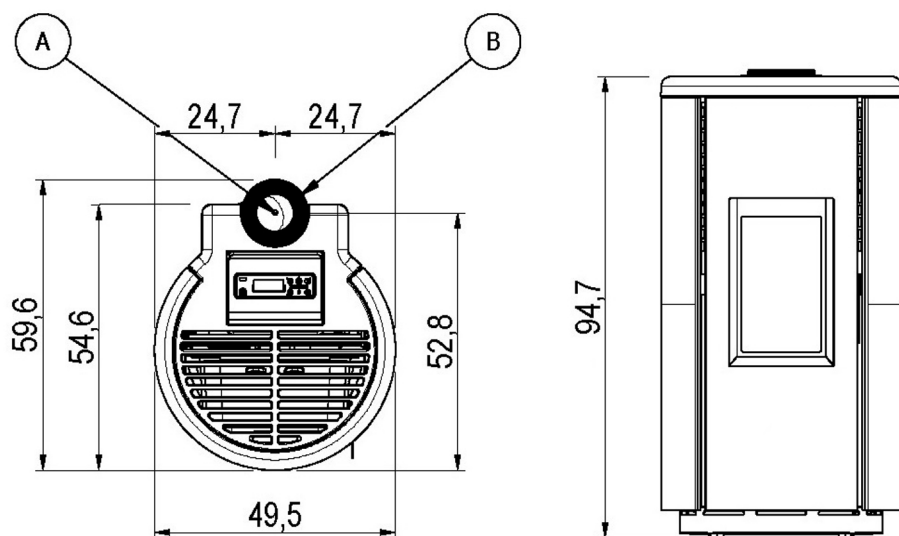

Hauteur, Largeur, Profondeur mm 943 x 498 x 597

Poids kg 76

Puissance nominale kw 7

Normes-EN : 14785/13240 EN14785

Rendement en % 90

Emission de CO à 13%O2 0.003

Emission de poussières mg/Nm3 13%O2 16

Diamètre sortie des fumées en mm 80/130

Diamètre prise d'air en mm (position) 80/130 dessus

Taille du réservoir en Kg 11

Durée max de fonctionnement 18

Consommation horaire mini-maxi 0.6 - 1.7

Distance de sécurité arrière 200 mm

Distance de sécurité latérale 300 mm

Distance de sécurité avant 1000 mm

